

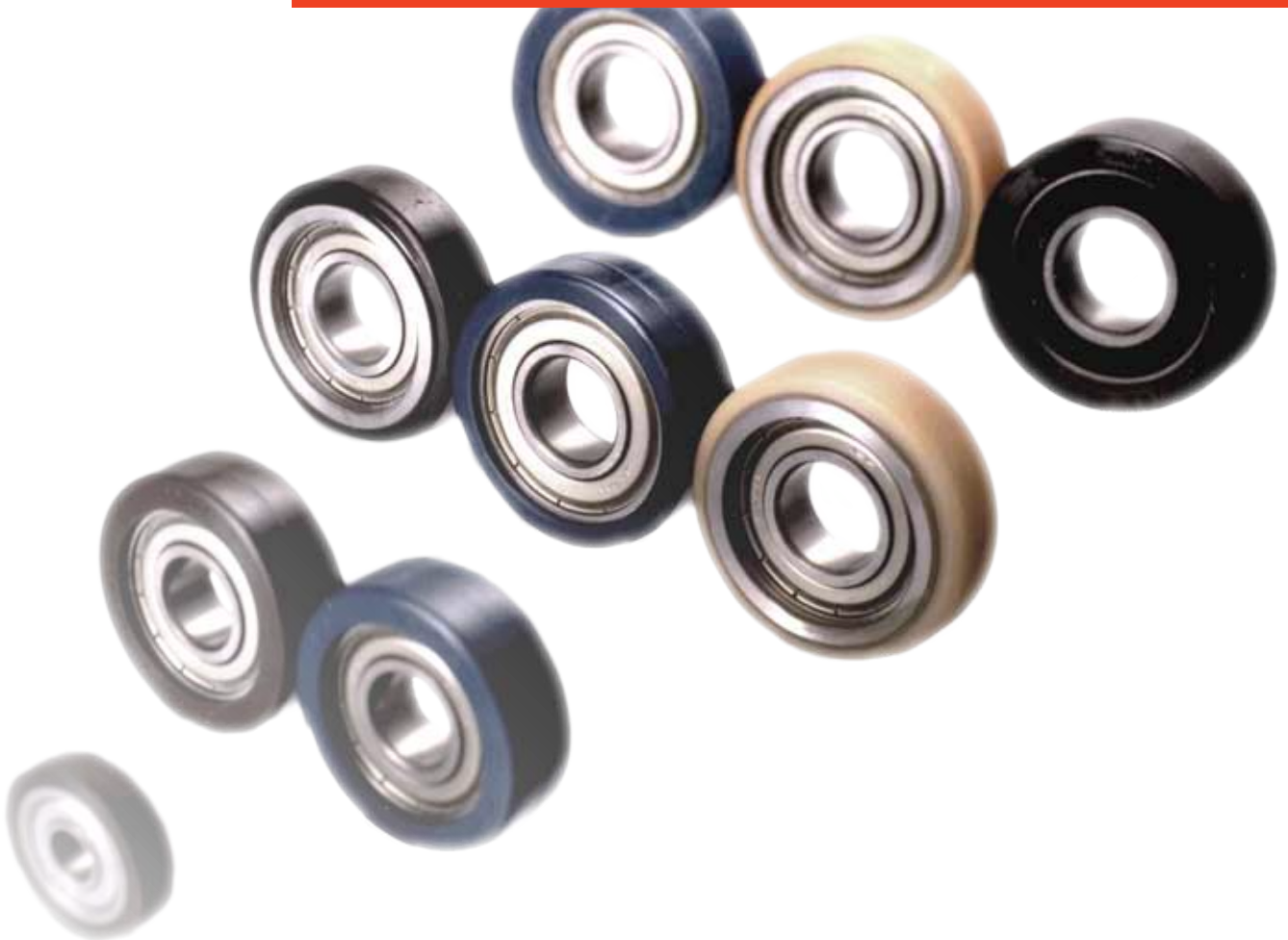

Bearing Components
Bancollan™ Bearings

Bancollan™ Bearings

Energy Saving No. 1



CONCEPT

BANCOLLAN™ Bearings are available in load tolerance type or low hardness friction type.



FEATURES

Good running resistance as the compound has little deformation due to load



Excellent abrasion resistance compared with metal rollers, and reduced noise

The load type is available in four different specifications, depending on the weight or the load

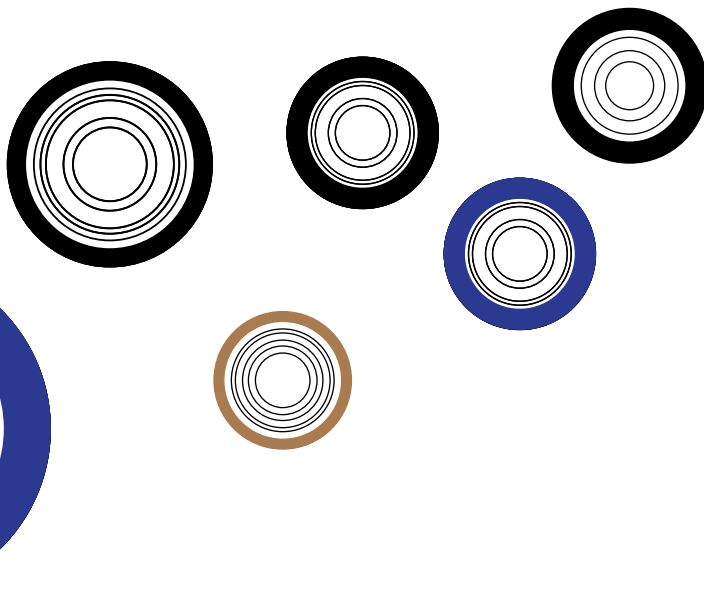
Low hardness friction types with increased gripping strength are also available

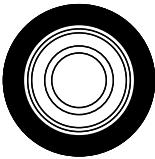
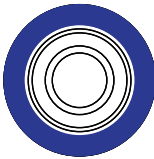

SELECTION GUIDE

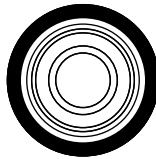
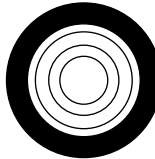
Type	Light Load L100	Medium Load L200	High Load L300	High Load L400	Friction F100
Color	Brown	Blue	Natural	Black	Brown
					
Features	Standard BANCOLLAN™ bearing.	A type with approximately 1.7-fold permissible load level of the light load type. This type has a longer service life than the light load type in the same conditions.	A type with approximately 2.7-fold permissible load level of the light load type.	A type with approximately 3.7-fold permissible load level of the light load type.	Uses BANCOLLAN™ with lower hardness than the load types and exhibits high gripping force.
Application Example	Airport hand baggage conveyance system Mail automatic sorting system Office document transportation system Chain conveyor system Automotive assembly line system Small package continuous vertical conveyance system Multi-story parking garage Cleanroom conveyance system Conveyance of charts, etc.				Bill exchanger, Automatic ticket gate Bankbook printer Automatic ticket vending machine Office copier, Automatic payment machine

APPLICATION EXAMPLES

CAR FACTORY

Only necessary parts of friction-driven urethane rollers operate. Energy saving is excellent, and the noise level is more than 10 dB lower than chain conveyors.

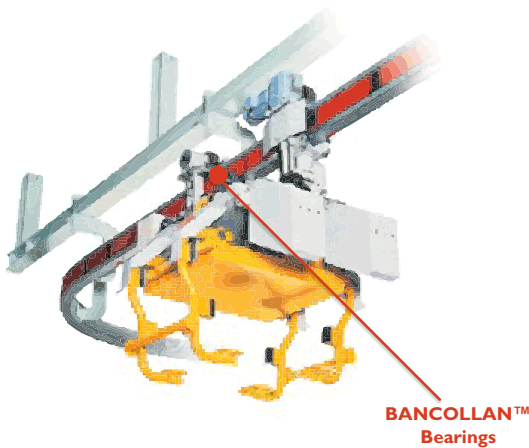

CLEAN ROOM

Antistatic Type - Electrical resistance: $1 \times 10^9 \Omega$ or less

Use for transportation of the IC / semiconductors / electronic components, which hate the static electricity.



MEDICAL DEVICE

Antistatic Type - Electrical resistance: $1 \times 10^9 \Omega$ or less

Use for transportation of the IC / semiconductors / electronic components, which hate the static electricity. E. g. CT scanner



BANCOLLAN™
Bearings

LOGISTICS

BANCOLLAN™ Bearings combine excellent energy saving with low noise level for application as plastic box transport systems and Roller conveyor transport systems.

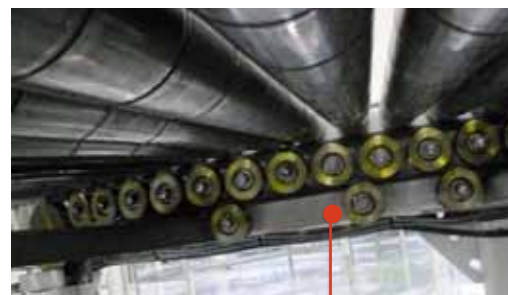

BANCOLLAN™
Bearings

Line Up (Shapes)

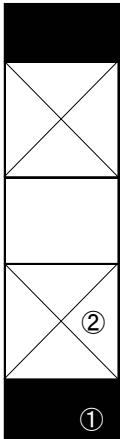
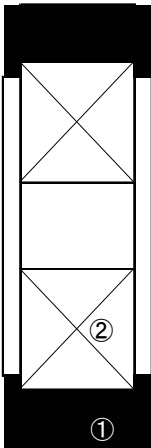
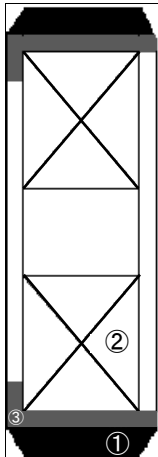
Shape BK	Shape B	Shape BB
		
<p>A type made by polishing Shape B to improve the vibration precision. This is used for the friction type.</p>	<p>This shape bonds BANCOLLAN™ directly on a metal bearing. The light load and medium load friction types have this shape.</p>	<p>This shape bonds BANCOLLAN™ on a metal core material and inserts a metal bearing into the core material. The high load and heavy load types have this shape.</p>

① BANCOLLAN™

② Bearing

③ Core material

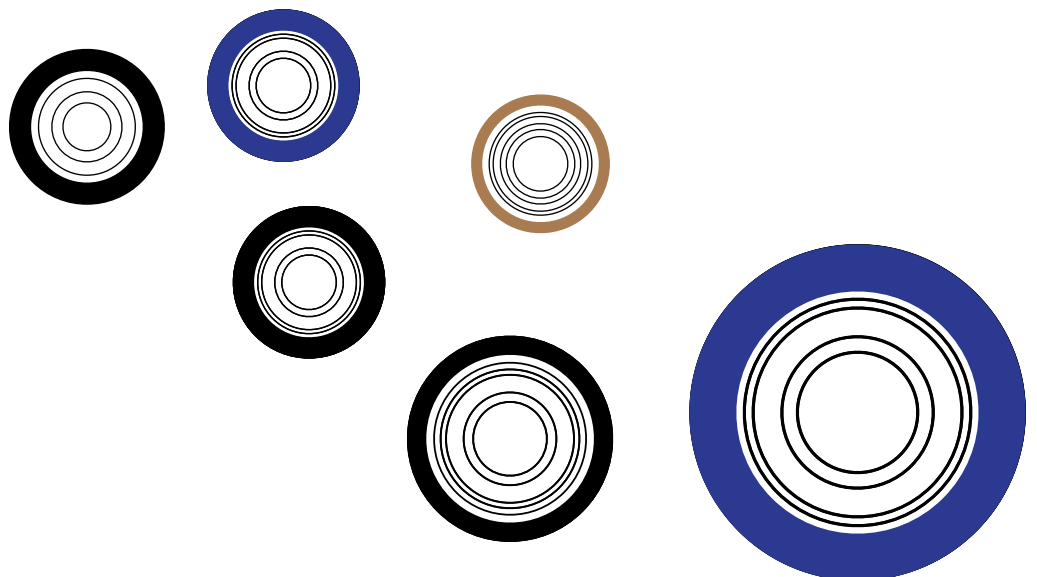

Line Up (Type, Sizes)

BANCOLLAN™ Bearing Types

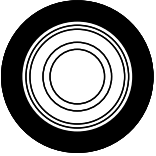
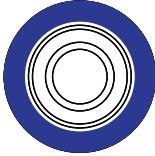
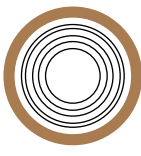
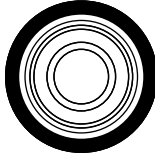
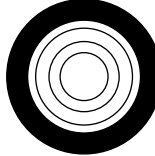
Light load (L100) Brown	Medium load (L200) Blue	High load (L300) Natural	Heavy load (L400) Black	Friction (F100) Brown
				

Outside Dia.	Light load (L100)	Medium load (L200)	High load (L300)	Heavy load (L400)	Friction (F100)	
	Shape B	Shape B	Shape BB	Shape BB	Shape B	Shape BK
13						●
15	●				●	
19						●
20	●				●	
24						●
25	●				●	
28						●
30	●	●	●	●	●	
35	●	●	●	●		
40			●	●		
45	●	●	●	●		
50			●	●		
55	●	●	●	●		
60			●	●		
65	●	●	●	●		
75			●	●		
85			●	●		

Line Up (Specification)

BANCOLLAN™ Bearings are available in load type and friction type with various dimension specifications.

L200-B-55-6204ZZ

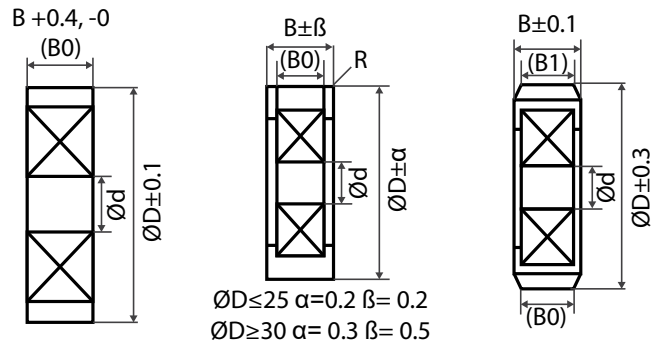
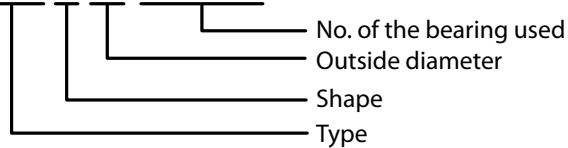

Common dimension [mm]			Shape BK		Shape B			Shape BB		
Outside Dia.	Inside Dia.	Width	Width	Bearing No.	R	Width	Bearing No.	Width		Bearing No.
D	d	B	B0			B0		B1	B0	
13	4	4	4	684ZZ						
15	4	6			0.5	4	684ZZ			
19	6	5	5	686ZZ						
20	6	8			1	5	696ZZ			
24	6	6	6	626ZZ						
25	6	9			1	6	626ZZ			
28	8	7	7	608ZZ						
30	8	11			1.5	7	608ZZ	7	6	698ZZ
35	8	11			1.5	7	608ZZ	7	7	608ZZ
40	12	14						10	8	6001ZZ
45	15	15			1.5	11	6202ZZ	11	9	6002ZZ
50	20	16						12	9	6904ZZ
55	20	18			1.5	14	6202ZZ	14	12	6004ZZ
60	20	18						14	14	6204ZZ
65	25	19			1.5	15	6205ZZ	15	15	6205ZZ
75	25	21						16	17	6305ZZ
85	30	23						18	19	6306ZZ



Bearing Components
Bancollan™ Bearings

INSTRUCTION FOR USAGE

Please contact us for detailed instruction.

* Please note that this catalogue is reserved to changes. All data in this publication have been compiled and checked with utmost diligence, nevertheless errors and mistakes cannot be totally excluded. Do not duplicate or copy any part or contents without the permission of Bando Europe GmbH.

Bando Europe GmbH
Krefelder Straße 671
41066 Mönchengladbach / Germany

Phone: +49 (0) 2161 - 901 04 0
E-Mail: info@bando.de
Web: www.bando.de