

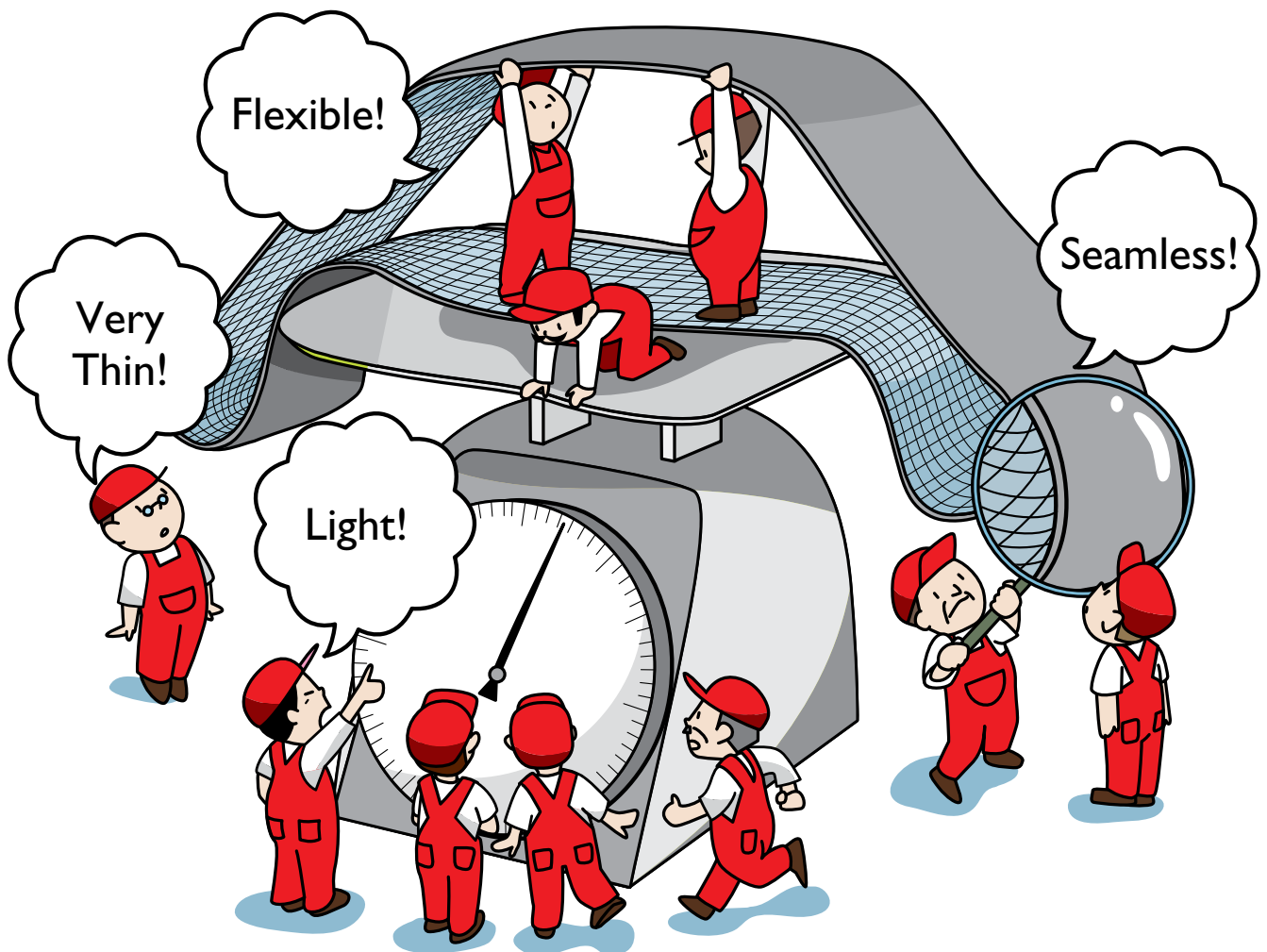

For cash counting & ATM

Precision Seamless Belt

E-Series



BENEFITS OF BANDO SEAMLESS BELTS

BANDO Precision Seamless Belt Series offers a wide product range of flat belts with various advantages.

Long Service Life

- Long durability thanks to seamless manufacturing

Superior Performance

- Tension adjustment not necessary
- Superior conveying ability
- Consistent belt thickness
- High flexibility for application with small pulleys

Eco-friendly

- Thinner belt for improved flexibility
- Less torque loss

APPLICATION

BANDO Precision Seamless Belt E-Series shows its superior performance and reliability in applications as:

Cash Counting Machine

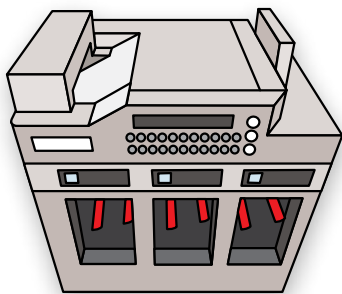

ATM



Automatic Ticket Gate

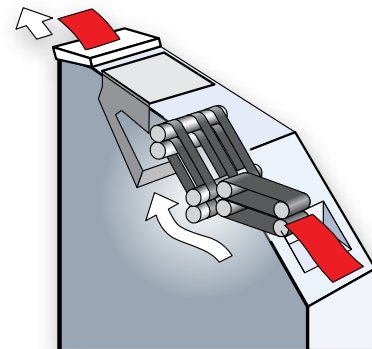

Further Applications: Amusement Equipment, Vending Machines and many more...

BANDO SOLUTIONS

BANDO Precision Seamless Belt E-Series was developed to avoid problems caused by:

High temperatures
and
humid environments

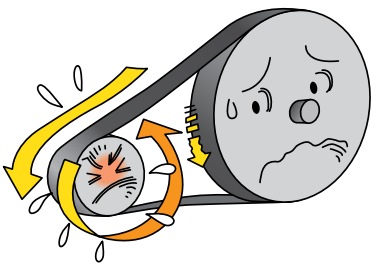

Conveying
issues

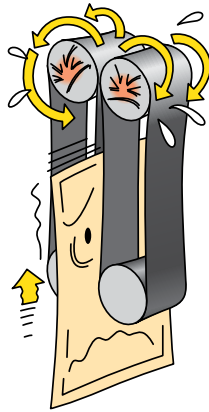

Belt damages due to
flange contact

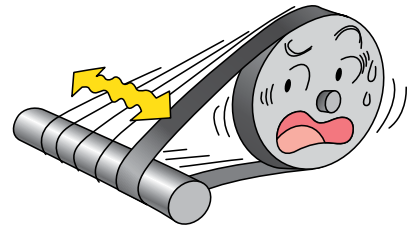

Your suitable E-Series Belt specification for reliable operation

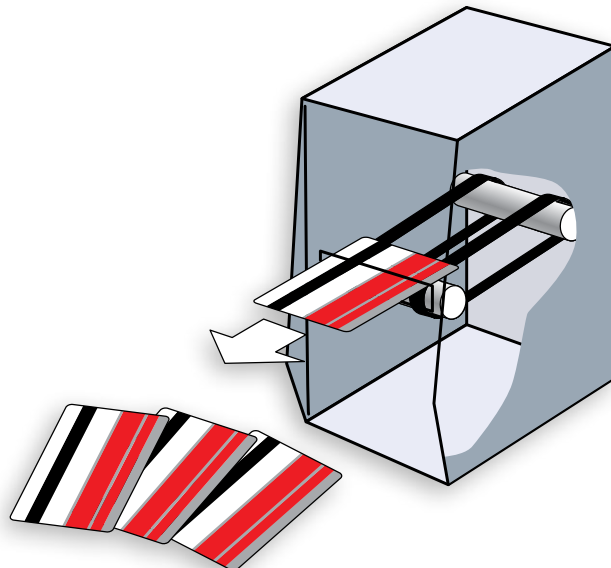

EXL-101

Optimum conveying of bank notes through sandwiching

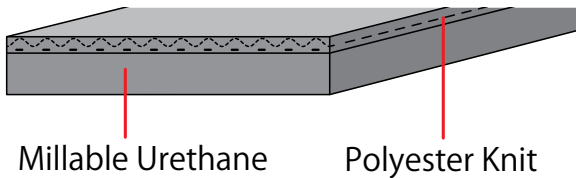

E-8U

Optimum conveying of paper and cards

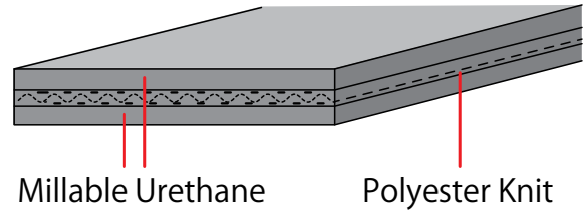

EXL-104

Advanced pull-and-grip feed performance for conveying bank notes

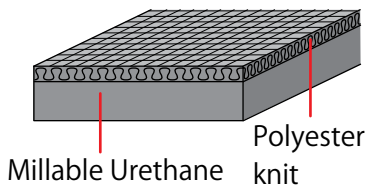

Reliable conveying performance

EXL-200

High performance EPDM-Specification

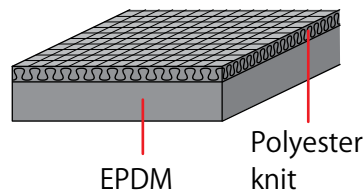

Reliable in high temperatures and humid environments

E-8U/T

Side tracking prevention

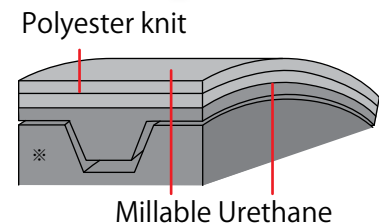

Reliable without flanges or avoids belt damage caused by flanges

PERFORMANCE BENCHMARK

Test Condition

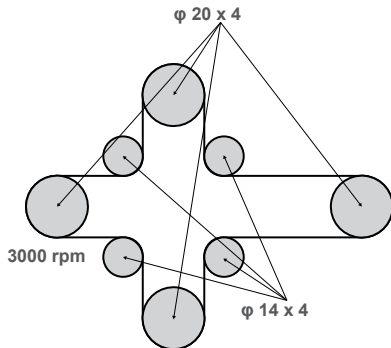

Elongation ratio: 10%, ambient temperature: 25 °C

Crack length change after 300 h

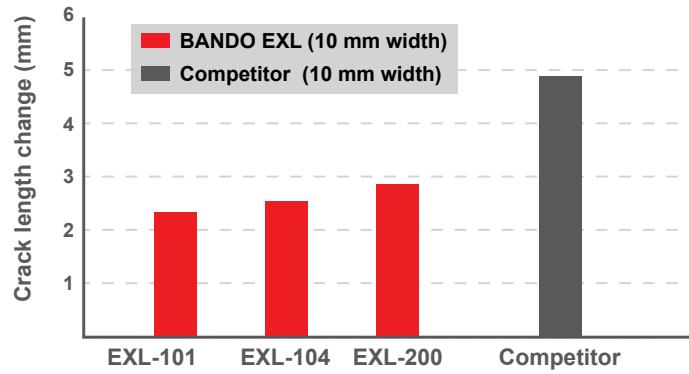

Test Condition

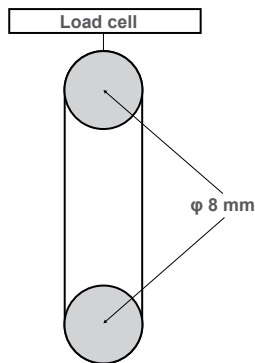

Elongation ratio: 95%, ambient temperature: 60 °C

Shaft load ratio change (Starting 100)

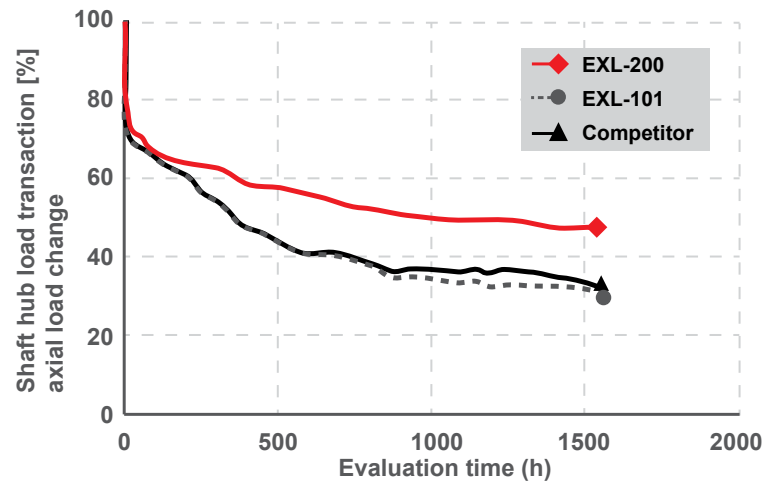

Test Condition

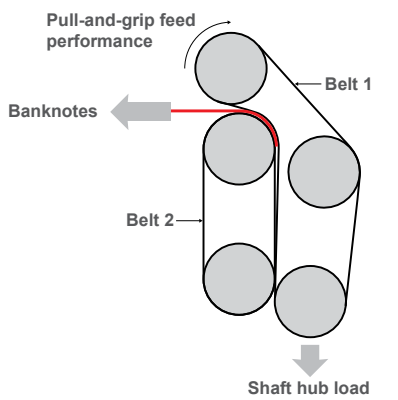

ambient temperature: 60 °C

Power transmission capability

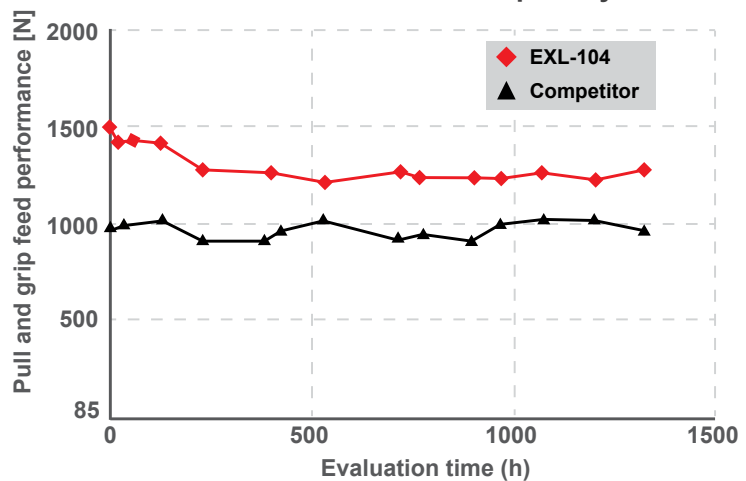

MANUFACTURING METHOD

Prepare the tension member (knitting) and select the mold according to layout length.

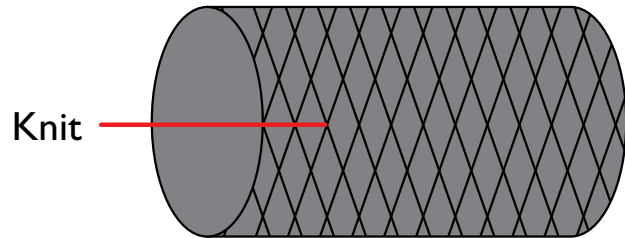

Molding including outer surface rubber. Thickness requirements can be specified.

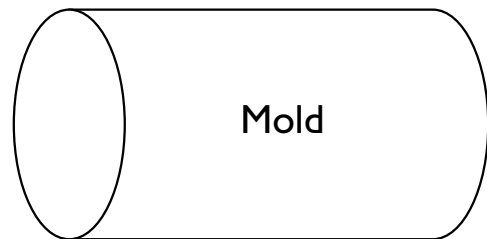

Cut belt width according to customer width requirements.

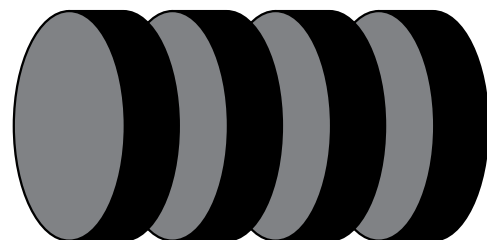

BELT SIZE LIST

Belt Type	Inner Belt Length																			
	41	66	72	76	82	90	92	95	99	103	104	106	110	114	116	118	120	121	125	128
E-8U *	131	134	136	138	140	143	145	148	149	151	152	154	155	157	159	162	164	165	166	167
	168	170	173	176	178	180	182	185	187	189	191	192	194	197	200	204	205	207	210	211
	212	214	216	219	221	224	228	232	235	239	240	241	243	245	247	248	250	253	256	258
	261	262	264	267	269	272	276	280	282	284	286	288	293	295	296	300	302	303	305	309
	312	314	318	321	323	328	331	334	335	336	338	341	342	343	347	348	353	354	356	358
	360	363	366	368	371	376	381	382	383	388	393	394	399	404	405	410	417	421	423	426
	431	435	438	442	444	445	447	453	457	462	467	471	477	479	482	484	487	490	494	497
	499	502	505	509	514	518	520	525	534	540	547	552	555	559	564	569	573	577	580	586
	591	593	597	603	608	613	619	625	632	643	650	658	661	667	672	674	680	683	690	698
	705	715	735	750	755	764	773	777	787	803	811	815	820	828	833	843	847	857	865	867
	875	881	899	909	914	925	934	943	947	949	965	969	994	995	1000	1012	1020	1029	1039	1055
	1061	1072	1100	1113	1150	1164	1219	1264	1335	1337	1398	1457	1579	1611						
	EXL-101	90	93	97	100	101	103	107	111	113	115	117	118	122	125	128	131	133	135	137
142		145	146	148	149	151	152	154	156	159	161	162	164	165	166	168	171	174	176	178
180		183	185	187	189	190	192	195	197	201	202	204	207	208	209	211	213	216	218	221
225		229	232	236	237	238	240	242	244	245	247	250	253	255	258	259	261	264	266	269
273		277	279	281	283	285	290	292	293	297	299	300	302	306	309	311	315	318	320	325
328		331	332	333	335	338	339	339	344	345	350	351	353	355	357	360	363	365	368	373
378		379	380	385	390	391	396	401	402	407	414	418	420	423	428	432	435	439	441	442
444		450	454	459	464	468	474	476	479	481	482	487	491	494	496	500	503	507	512	516
518		523	532	538	545	548	553	557	562	565	569	573	578	584	589	591	594	600	605	610
616		622	629	640	647	655	658	664	669	671	677	680	687	694	699	709	729	744	749	758
767		771	781	797	805	809	814	822	827	837	842	852	860	862	870	876	893	903	908	919
928		937	941	943	959	963	988	989	994	1006	1014	1023	1033	1049	1055	1066	1093	1106	1143	1157
1212		1257																		

* For E-8U/T (with V guide), please contact us with size requirements



For cash counting & ATM

WIDE VARIETY PRODUCT LINE-UP

Ceptor VI

Noise reduction and narrow width for use in small space



Bancollan Synchronous

High conveyance precision and rubber dust free



Ultra Flexible Synchronous

Optimum conveying of paper and cards



Synchronous Pulley (Resin Plastics and Metals)



* Please note that this catalogue is reserved to changes. All data in this publication have been compiled and checked with utmost diligence, nevertheless errors and mistakes cannot be totally excluded. Do not duplicate or copy any part or contents without the permission of Bando Europe GmbH.